



Since 2000

# SONI

ALU GLAZE SYSTEM

## Windows & Doors Re-Imagined!



Sr. No.	Content Name	Page No.
1	WHY ALUMINIUM WINDOWS & DOORS	02
2	BENEFITS, FEATURES	02
3	ABOUT US, MISSION, VISION	03
4	JOURNEY	04
5	SLIDING WINDOW	05
6	SLIM WINDOW	07
7	CASEMENT WINDOW	09
8	TILT AND TURN	10
9	STRUCTURAL GLAZING	11
10	CASEMENT DOOR	12
11	MOVABLE LOUVERS DOOR	13
12	SLIDING FOLDING DOOR	14
13	ALUMINIUM SLIM PARTITION & DOOR	15
14	ALUMINIUM GLASS RAILING	16
15	LIFT AND SLIDE DOOR	17
16	WHY US	18
17	PROJECTS	19
18	CONTACT US	19



# WHY ALUMINIUM WINDOWS & DOORS



- Aluminum windows and doors combine strength, design flexibility, energy efficiency, and low maintenance, making them an excellent choice for both residential and commercial spaces.
- You can also choose from a vast array of colors to suit your home, including a dual-color option where the inside and outside colors can be different.



## BENEFITS



Easy To Maintain



Impact Resistant



Durable



Best in Class Warranty



Affordable



Anti-Burglary Lock For Extra Security



Sound Insulation



No Termites



Wind Load Bearing Capacity

## FEATURES



Thermal Efficiency



Immunity to Dust



Air Permeability



Corrosion Resistant



Design Adaptability



Water Intrusion



Water Tightness



Drought



Custom-Engineered Rollers

## ABOUT US



- Soni Alu Glaze System has been making, providing, and building solutions for the architectural and building industries that enhance façades for more than 22 years.
- We have a diverse collection of top-notch double-glazing products, including windows, doors, conservatories, and orangeries.
- Our commitment to excellence shines through not only in our products but also in our exceptional customer service.
- Our products are carefully manufactured at our Dantali Manufacturing Unit, using specialized machinery imported from Italy.
- We offer a variety of styles that match the look of the home and offices
- With a wide range of products to suit any budget, we have something for everyone.

150+

Buidings

100+

Clients

100K+

Windows

## VISION

We envision becoming one of the top manufacturers in Gujarat creating sustainable, aesthetically pleasing and technologically advanced aluminium doors and windows solutions by 2028.

## MISSION

We aim to consistently & timely deliver top-quality products with customer satisfaction, and continuously innovate to meet our customers' ever-evolving needs.

## JOURNEY

Mr. Rajesh Soni started as a Workman

2000

Started a Manufacturing Unit, 1000 Sq. Ft.

2011

Started Manufacturing Unit & Display unit of 7,000 Sq. Ft. at Dantali GIDC

2022

2006

Established Own Small Firm

2016

Expanded to 5,000-Sq.Ft. with Imported CNC Cutting Machine from Italy



Sliding window features two (or more) horizontal windows fitted with rollers at the bottom for swift sideways movement on tracks.

## SAG-25MM

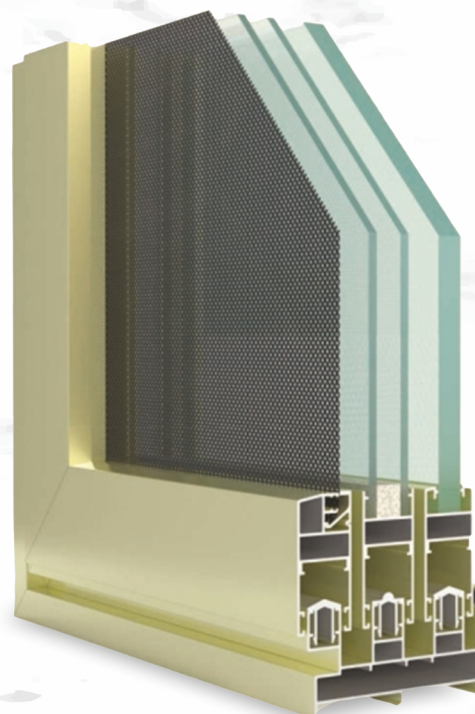
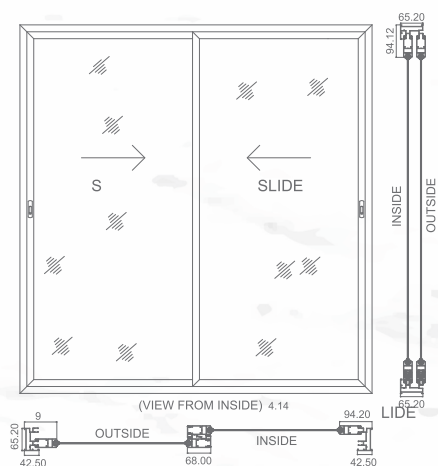

### Euro Slim Series

Shutter Size	25 mm x 63 mm
2 Track	51 mm x 40 mm
3 Track	101 mm x 43 mm
Window Height	Max. 1800 mm
Sash Weight	Max. 70 Kgs
Hardware	Single/ Multipoint Lock
Joinery Detail	45°/ 90° with Corner Connector
Glazing Option	Single/ DGU
Mosq. Mesh	Tear Resistant SS Mesh
Finishing	Powder Coating (PU/ Textured finish/ Wood finish)

Application



Bedrooms



Balconies



Large/Tall openings



## SAG-27MM

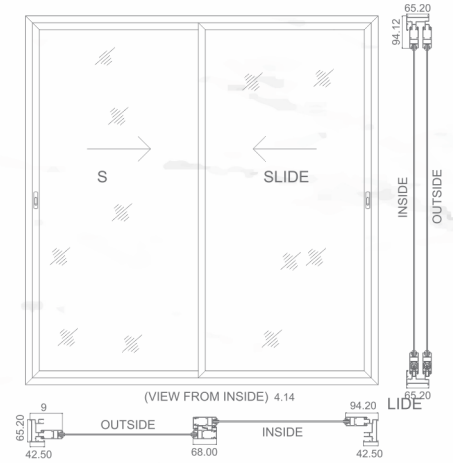
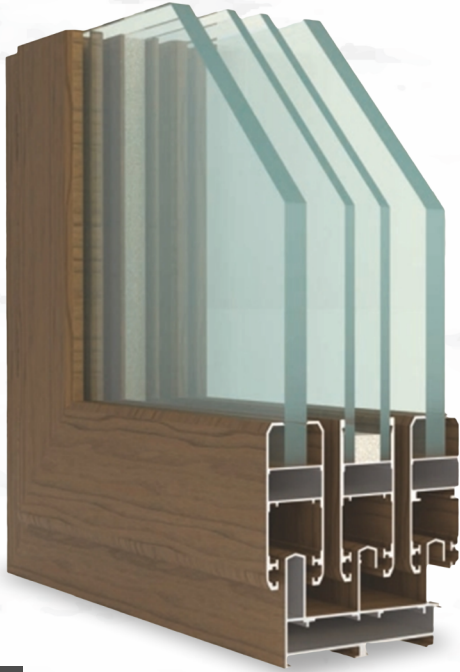

### Domal

Shutter Size	27 mm x 65 mm
2 Track	45 mm x 45 mm
3 Track	80 mm x 45 mm
Window Height	Max. 1800 mm
Sash Weight	Max. 80 Kgs
Hardware	Single/ Multipoint Lock
Joinery Detail	45° with Corner connector
Glazing Option	Single/ DGU/ Laminate
Mosq. Mesh	Tear Resistant SS Mesh
Finish	Powder Coating (PU/ Textured Finish/ Wood Finish)

### Application



Bedrooms



Balconies



Large/Tall openings

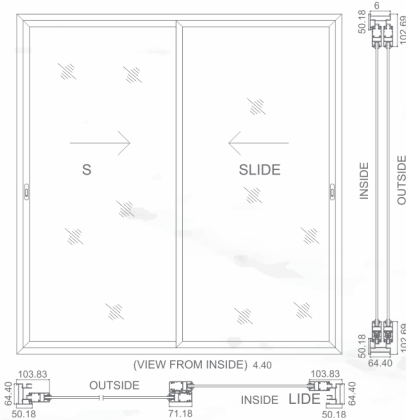

## SAG-29MM

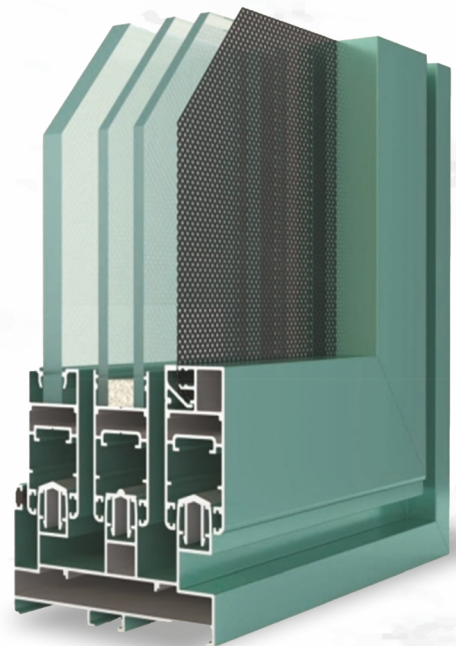

Shutter Size	29 mm x 65 mm
2 Track	50 mm x 48 mm
3 Track	86 mm x 48 mm
Window Height	2400 mm
Sash Weight	120 Kgs
Hardware	Single/ Multipoint Lock
Joinery Detail	45° with Corner Connector
Glazing Options	Single/ Laminated/ DGU
Mosq. Mesh	Tear Resistant SS Mesh
Finish	Powder Coating (PU/ Textured finish/ Wood finish)

### Application



Bedrooms



Balconies



Large/Tall openings

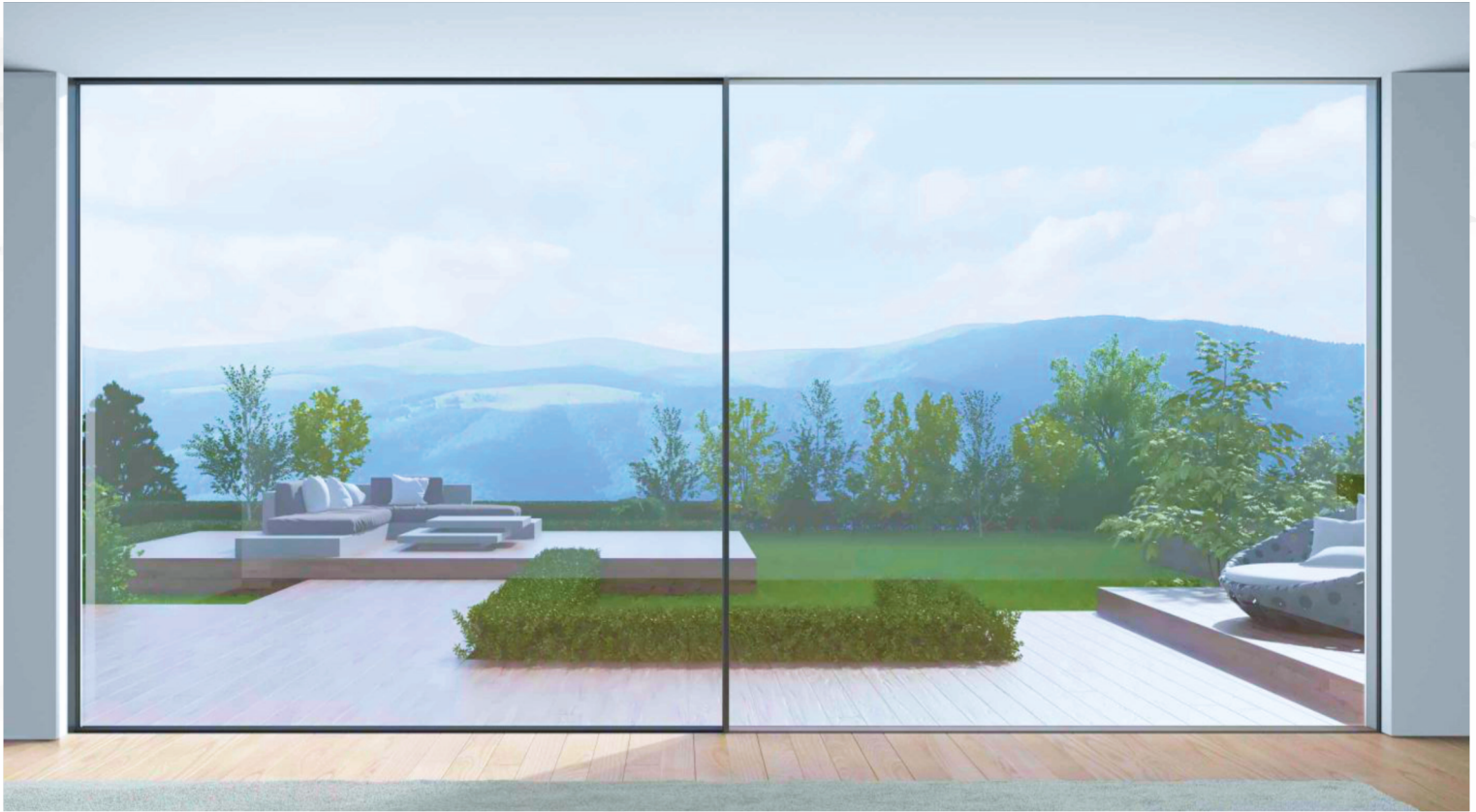

Slim Aluminum windows which have hidden frames that are smaller and less visible than the regular windows and doors.

## SAG-32MM

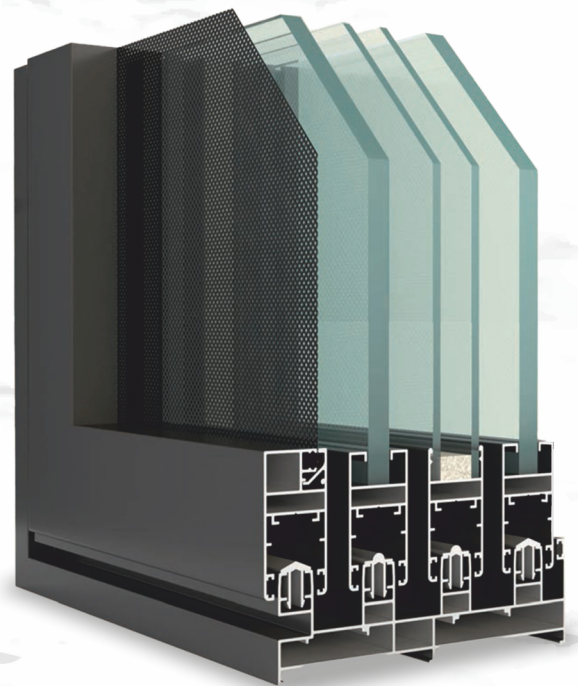
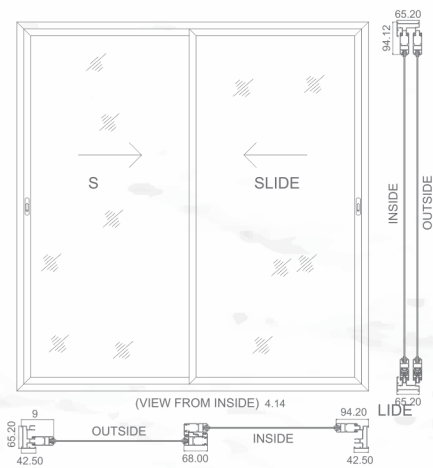

Shutter Size	32 mm x 58 mm
2 Track	87 mm x 40 mm
3 Track	132 mm x 40 mm
Window Height	Max. 3000 mm
Sash Weight	Max. 120 Kgs
Hardware	Single/ Multipoint Lock
Joinery Detail	45°/ 90° with Corner Connector
Glazing Option	Single/ Laminated/ DGU
Mosq. Mesh	Tear Resistant SS Mesh
Finish	Powder Coating (PU/ Textured Finish/ Wood Finish)

Application



## SAG-35MM Gulf



Shutter Size	35 mm x 59 mm
2 Track	100 mm x 33 mm
3 Track	150 mm x 33 mm
Window Height	3000 mm
Sash Weight	120 Kgs
Hardware	Single/ Multipoint Lock
Joinery Detail	45°/ 90° with Corner Connector
Glazing Options	Single/ Laminated/DGU
Mosq. Mesh	Tear Resistant SS Mesh
Finish	Powder Coating (PU/ Textured Finish/ Wood Finish)

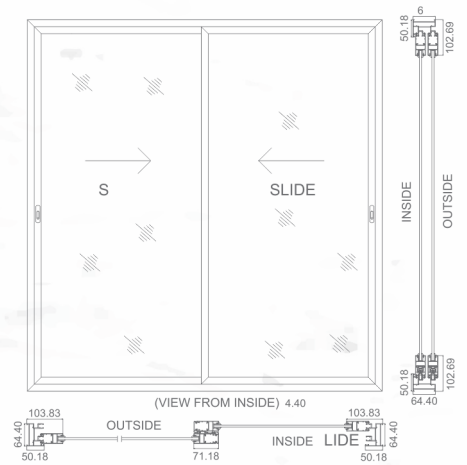

### Application



Bedrooms



Balconies



Large/Tall  
openings

## SAG-40MM



Shutter Size	40 mm x 60 mm
2 Track	106 mm x 50 mm
3 Track	157 mm x 50 mm
4 Track	208 mm x 50 mm
Window Height	3000 mm
Sash Weight	150 Kgs
Hardware	Single/ Multipoint Lock
Joinery Detail	45°/ 90° with Corner Connector
Glazing Options	Single/ Laminated/ DGU
Mosq. Mesh	Tear Resistant SS Mesh
Finish	Powder Coating (PU/ Textured Finish/ Wood Finish)

### Application



Bedrooms



Balconies



Large/Tall  
openings





## SAG-40MM

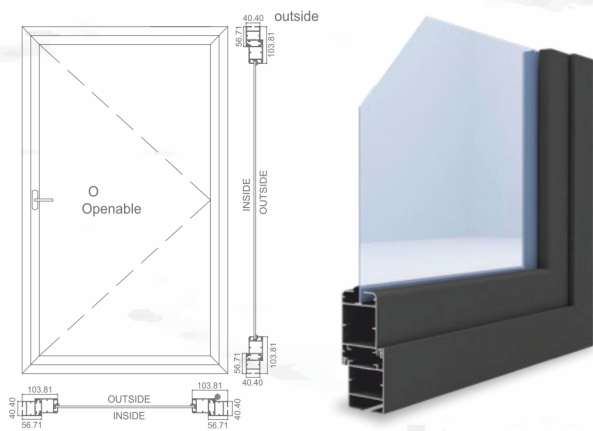

Shutter Size	40 mm x 54 mm
Frame Size	40 mm x 39 mm
Window Height	Max. 1800 mm
Sash Width	Max. 650 mm
Sash Weight Max	50 Kg
Hardware	Single Point
Hinge	Butt Hinge/ Friction Hinge
Joinery Detail	45° with Corner Connector
Glazing Options	Single/ Laminated/ DGU
Mosq. Mesh	Roll Down/ Retractable
Finish	Powder Coating (PU/ Textured Finish/ Wood Finish)
Opening	Side Hung/ Top Hung

## SAG-50MM

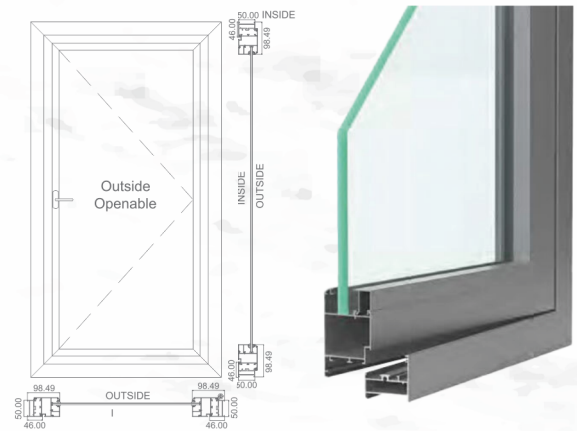

Shutter Size	58 mm x 78.5 mm
Frame Size	50 mm x 46 mm
Window Height	Max. 2000 mm
Sash Width	Max. 700 mm
Sash Weight	Max. 80 Kg.
Hardware	Single/ Multipoint Locking
Hinge	Butt Hinge/ Friction Hinge
Joinery Detail	45° with Comer Connector
Glazing Options	Single/ Laminated/ DGU/ DGU With Integrated Blinds
Finish	Powder Coating (PU/ Textured Finish/ Wood Finish)
Opening	Side Hung/ Top Hung

Application



Bedrooms



Balconies



Large/Tall openings



## SAG-40MM

Shutter Size	40 mm x 88 mm
Frame Size	40 mm x 46 mm
Window Height	Max. 1800 mm
Sash Width	Max. 650 mm
Sash Weight Max	50 Kg
Hardware	Multipoint Lock
Hinge	Butt Hinge/ Friction Hinge
Joinery Detail	45° with Corner Connector
Glazing Options	Single/ Laminated/ DGU
Mosq. Mesh	Roll Down/ Retractable
Finish	Powder Coating (PU/ Textured Finish/ Wood Finish)
Opening	Side Hung/ Top Hung



### Application



Bedrooms



Balconies



Large/Tall openings





Structural glazing involves large glass panels, which usually bear some weight in the structure.

Frame Size	67 mm x 81 mm to 67 mm x 132 mm
Window Height	Max. 1800 mm x 900 mm
Sash Width	Max. 650 mm
Sash Weight Max	50 Kg
Hardware	Multipoint Lock
Hinge	Butt Hinge/ Friction Hinge
Joinery Detail	45° with Corner Connector
Glazing Options	Single/ Laminated/ DGU
Mosq. Mesh	Roll Down/ Retractable
Finish	Powder Coating (PU/ Textured Finish/ Wood Finish)
Opening	Top Hung/ Parallel Hung



Top Hung



Parallel Hung

## Application



Hotels



Commercial Buildings



Airport





## SAG-40MM

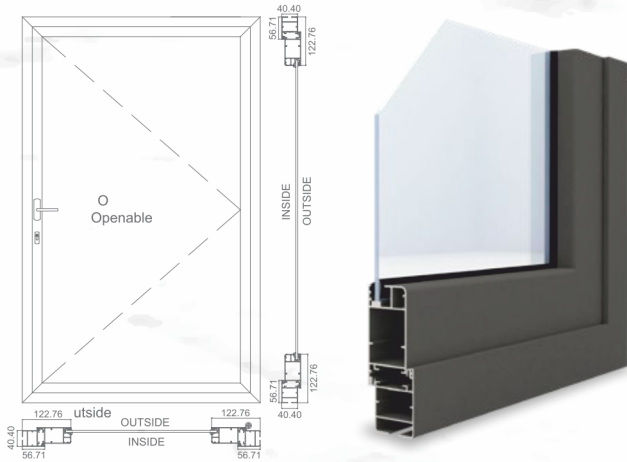

Shutter Size	40 mm x 70 mm
Frame Size	40 mm x 55 mm
Window Height	Max. 2400 mm
Sash Width	Max. 900 mm
Sash Weight	Max. 80 Kgs
Hardware	Single Point Lock
Hinge	Butt Hinge
Joinery Detail	45° with Corner Connector
Glazing Options	Single Glass/ HPL Sheet
Mosq. Mesh	Roll Down/ Retractable
Finish	Powder Coating (PU/ Textured Finish/ Wood Finish)
Operating	Side Hung

## SAG-50MM

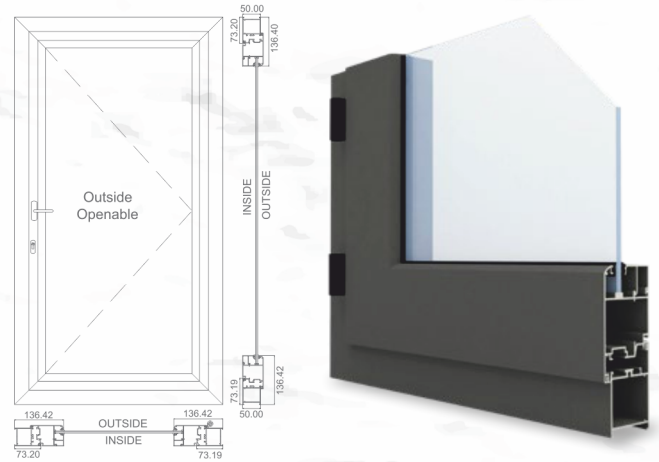

Shutter Size	58 mm x 92.5 mm
Frame Size	50 mm x 73 mm
Window Height	Max. 2400 mm
Sash Width	Max. 1200 mm
Sash Weight	Max. 120 Kg.
Hardware	Single/ Multi-point Lock
Hinge	Butt Hinge
Joinery Detail	45° with Corner Connector
Glazing Options	Single/ Laminated/ DGU
Finish	Powder Coating (PU/ Textured Finish/ Wood Finish)
Operating	Side Hung

Application



Balconies



Large/Tall openings



Luxury Bungalows



Villas



## SAG-50MM

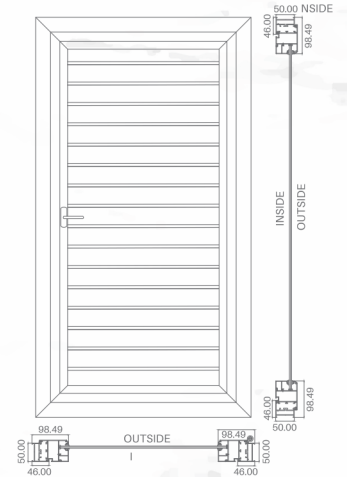

Shutter Size	58 mm x 78.5 mm
Frame Size	50 mm x 46 mm
Sash Width	Max. 700 mm
Window Height	Max. 2000 mm
Sash Weight	Max. 80 Kgs
Hardware	Single/ Multi-point Lock
Hinge	Butt Hinge/ Friction Hinge
Joinery Detail	45 ° with Corner Connector
Glazing Options	Aluminium Movable Louvers
Finish	Powder Coating (PU/ Texture Finish/ Wood Finish)
Opening	Side Hung

### Application



Hotels



Luxury Bungalows



Villas



# SLIDING FOLDING DOOR



## SAG-50MM

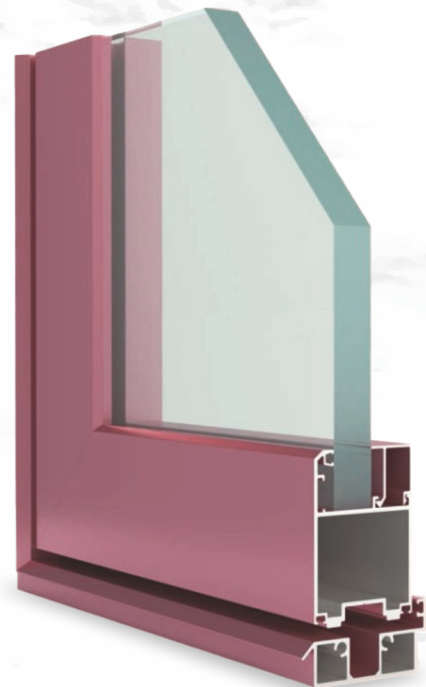
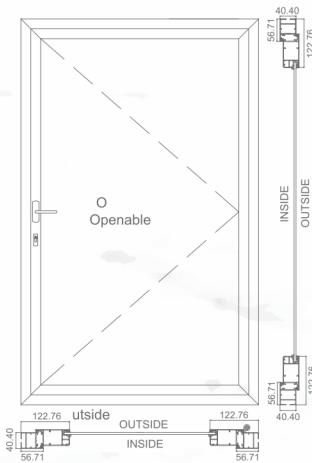

Shutter Size	50 mm x 76.5 mm
Vertical Frame Size	52.5 mm x 71 mm
Top Frame Size	71 mm x 73.75 mm
Bottom Frame Size	57.80 mm x 31.5 mm
Window Height	Max. 2400 mm
Sash Width	Max. 1100 mm
Sash Weight	Max. 100 Kgs
Hardware	Multi-point Lock
Hinge	Butt Hinge
Joinery Detail	45° with Corner Connector
Glazing Options	Single Glass/ Laminated/ DGU
Mosq. Mesh	Roll Down/ Retractable
Finish	Powder Coating (PU/ Texture Finish/ Wood Finish)
Operating	Side Hung
Opening Area	100%

### Application



Bedrooms



Balconies



Large/Tall openings



# ALUMINIUM SLIM PARTITION & DOOR



## SYNCHRO SLIDING

## TELESCOPIC SLIDING



Aluminium partition panels are non-corrosive and come in mill finish, anodized finish or powder coated finish

Frame Size: 16mm x 45mm, 25mm x 45mm

Application



Hotels



Commercial Buildings



Large/Tall openings



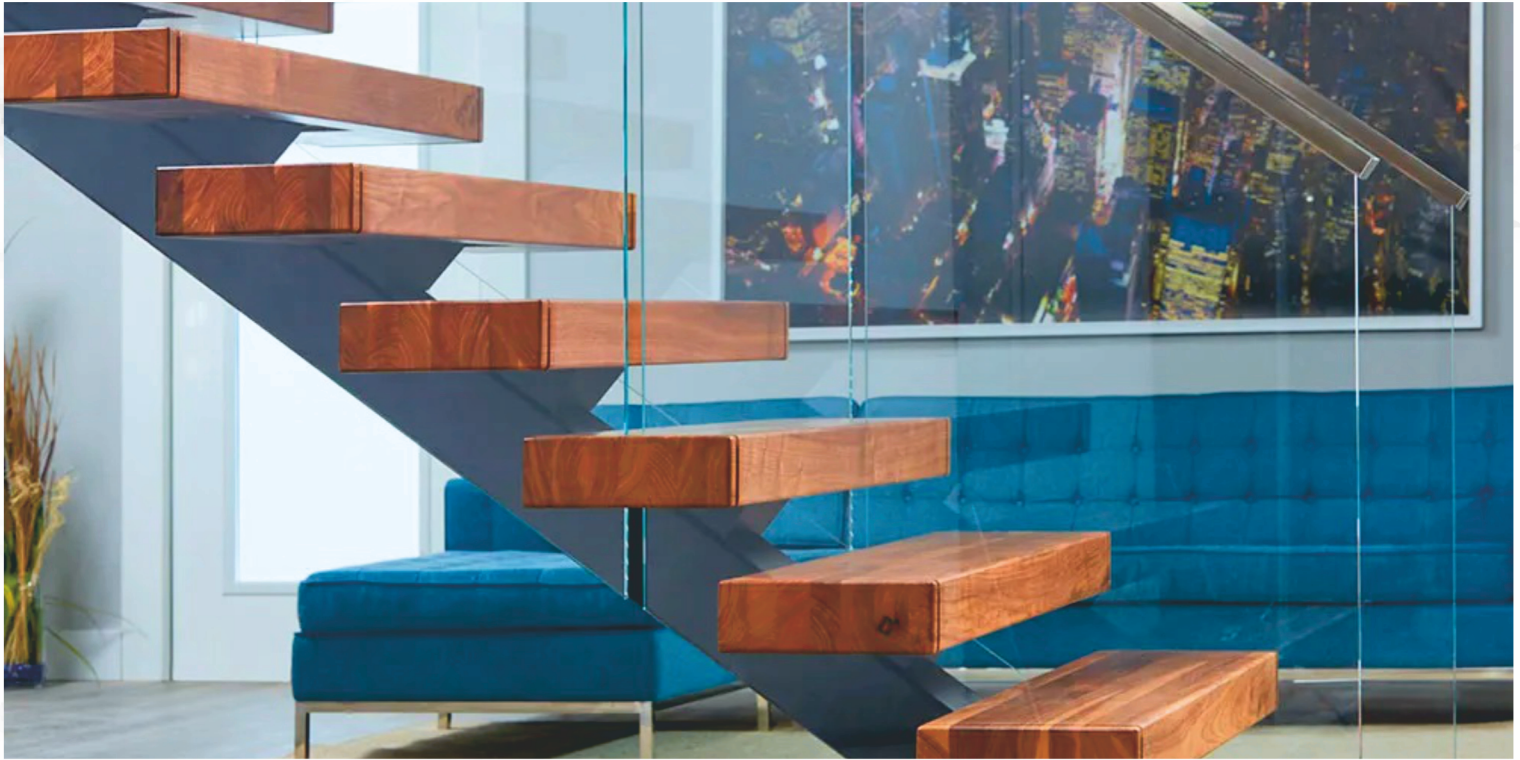

Aluminium Glass Railing is a system where the glass panels are secured with standoffs of Aluminium.

Glass: 12 mm Toughened / Laminated

## Application



Balconies



Commercial Buildings



Villas





Lift & Slide doors are a much sought-after choice for large spans that link inside with outside. These doors glide back and forth on feather touch rollers, and provide rich panoramic views through their expansive glass panes.

Shutter Size	103 mm x 59 mm
Frame Size	129 mm x 51 mm
Window Height	Max. 1800 mm x 900 mm
Sash Width	Max. 650 mm
Sash Weight Max	50 Kg
Hardware	Multi-point Lock
Hinge	Butt Hinge/ Friction Hinge
Joinery Detail	45° With Corner Connector
Glazing Options	Single Laminated/ DGU
Mosq. Mesh	Roll Down/ Retractable
Finish	Powder Coating (PU/ Texture Finish/ Wood Finish)
Opening	Top Hung/ Side Hung/ Parallel Hung



Balconies



Large/Tall openings



Luxury Bungalows



Villas

## Application



# 12MM TOUGHENED GLASS



## SHOWER CUBICLE DOOR & FIX



## DOOR & FIX



## GLASS RAILING

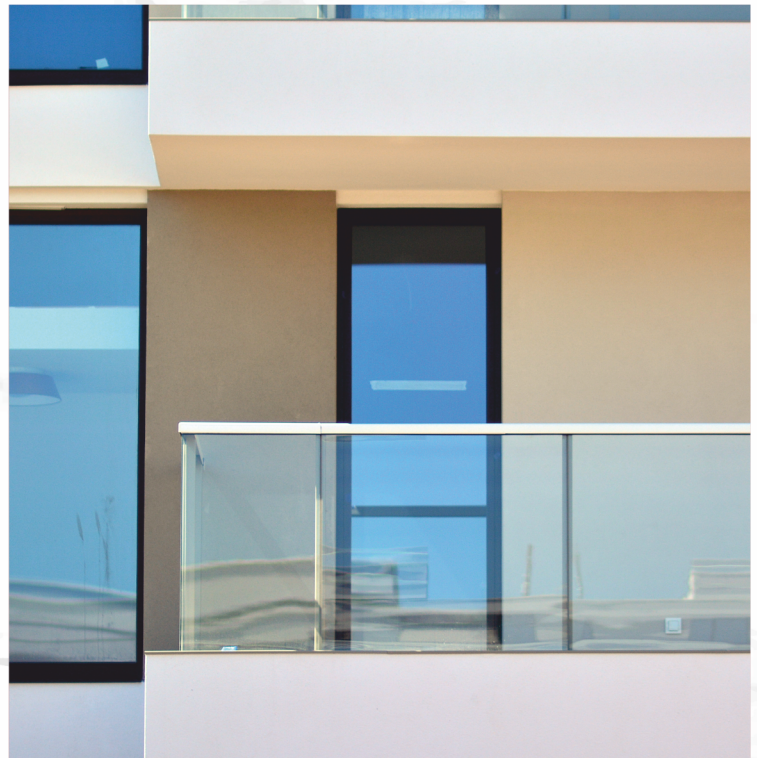





# WHY US

22+ Years of Experience

In-house Manufacturing Facility

High Quality Products

Sustainable Products

5 Years of Warranty of All Products

On-Time Project Completion

Strong After Sales Support

State of the Art Modern Italian Machinery

Professional Approach

# OUR MACHINERY



**Fom Industrie - Aluminium CNC Cutting Machine from Italy**



**Copy Router**  
To create Lock Sections



**Punching Machine**

## PROJECTS



Karnavati Gokuldham, Karnavati Riverside,  
Karnavati Infinity, Karnavati Vivanta,  
Karnavati Premium Living,  
Karnavati Celestial Living



Venue 82 - Shilaj



Sky Lon - ChanakyaPuri



Sepal Azalia - Shilaj



Kala Tirth, Kala Tirth Premium, Kala Dhaam,  
Kala Siddhi, Nirmal Kala - Motera



Sparsh Arise, Sparsh Aron,  
Sparsh Arista - Vasna



Nilkanth Villa - Shilaj,  
Neelkanth Patang Hotel - The Revolving Restaurant 

## CONTACT US

P: Rajesh Soni: 98250 04454 E: [sonialuglazsystem82@gmail.com](mailto:sonialuglazsystem82@gmail.com)

A: Plot No 14, K.C.Thakor Estate, near Grundfos, Ice Make Refrigeration Ltd. Road,  
Dantali GIDC, Lapkaman-Vadsar Road, Kalol, Gujarat - 382721

